

## Thule ThruRide 565

# › Instructions

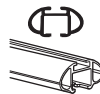

THULE WingBar



THULE AeroBar



THULE SlideBar



THULE ProBar

**565001**

C.20151019  
501-8124-01

Bring your life  
thule.com

**EN** Roof-mounted bike carrier  
**DE** Dachfahrradträger  
**FR** Porte-vélo sur le toit  
**NL** Fietsdrager voor op het dak  
**IT** Portabici da installare sul tetto  
**ES** Portabicicletas de techo  
**PT** Suporte para bicicleta para teto  
**SV** Takmonterad cykelhållare  
**DK** Tagmonteret cykelholder  
**NO** Takmonterte lasteholdere  
**FI** Katolle asennettava polkupyöräteline  
**ET** Katusele paigaldatav jalgrattahoidik  
**LV** Uz jumta uzstādāms velosipēdu turētājs  
**LT** Ant stogo tvirtinami dviračių laikikliai  
**PL** Bagażnik rowerowy montowany na dachu  
**RU** Устанавливаемое на крыше крепление для велосипедов

**UK** Багажник для велосипедів, що монтується на даху  
**BG** Покривен багажник за велосипеди  
**CS** Nosič jízdních kol s montáží na střechu  
**SK** Nosič bicyklov s montážou na strechu  
**SL** Nosilec za kolesa  
**HR/BiH** Krovni nosač bicikla  
**RO** Suport pentru bicicletă montat pe pavilion  
**HU** Tetőre szerelhető kerékpártartó  
**EL** Σχάρα ποδηλάτου οροφής  
**TR** Araç üstüne bağlanan bisiklet taşıyıcı  
**HE** משא אופנים על הגג  
**AR** حامل الدراجة للتثبيت على السقف  
**ZH** 頂置自行車架  
**JA** ルーフマウント型サイクルキャリア  
**KO** 지붕 장착 자전거 캐리어  
**TH** โครงยึดจักรยานแบบติดตั้งบนหลังคา

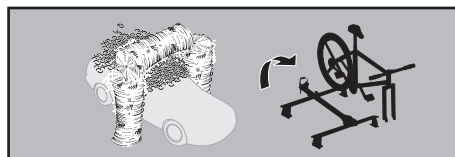
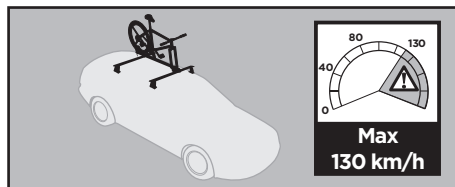
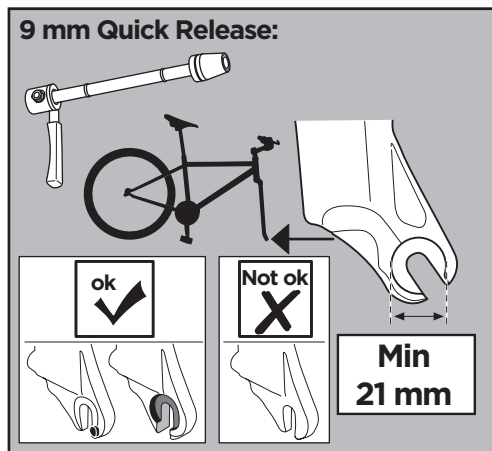
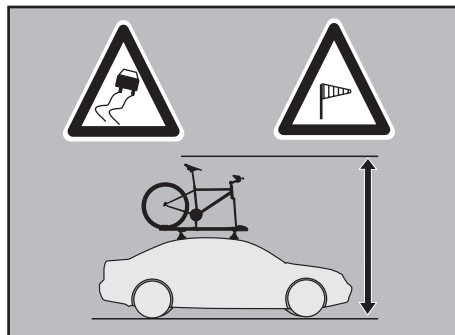
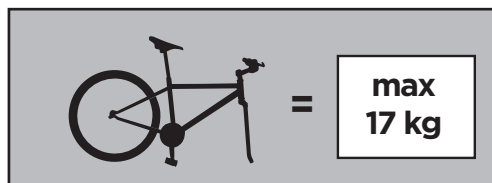
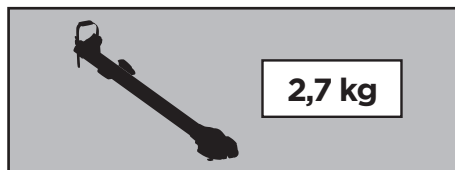
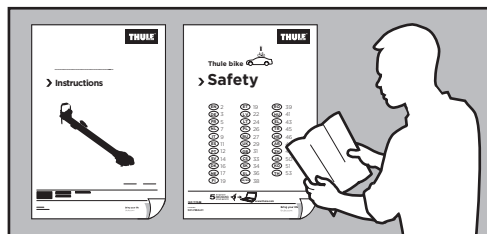

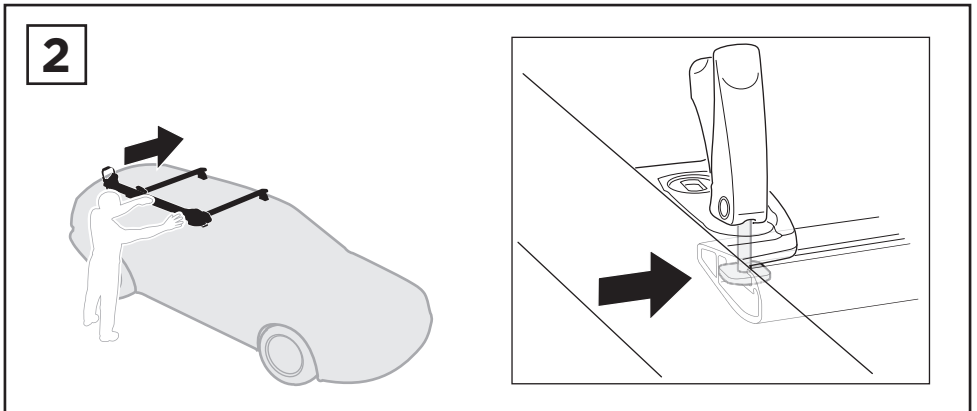
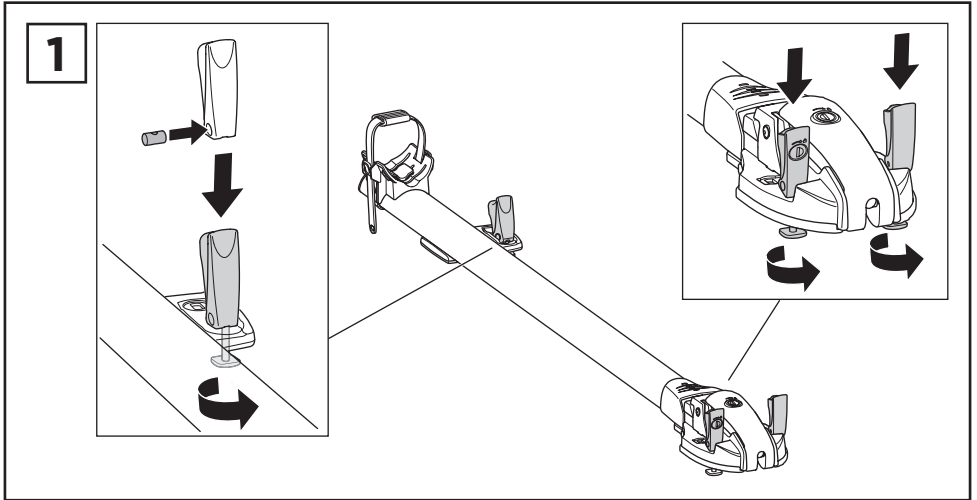
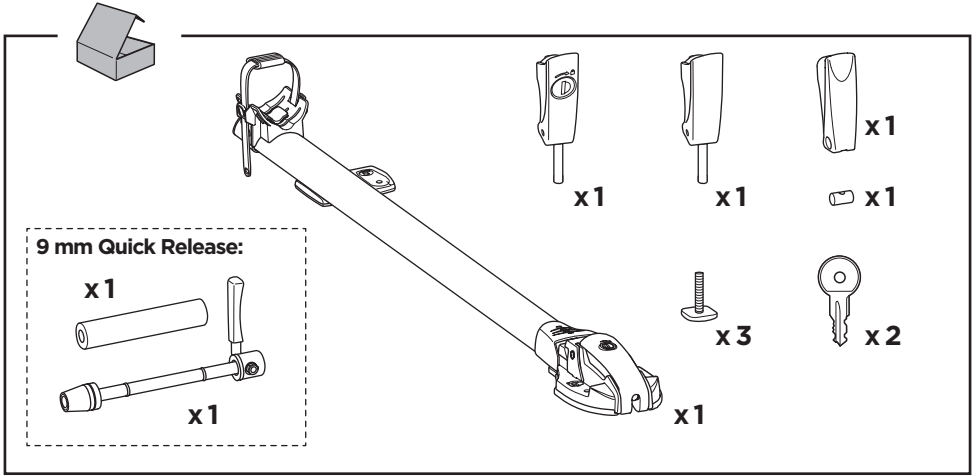

3

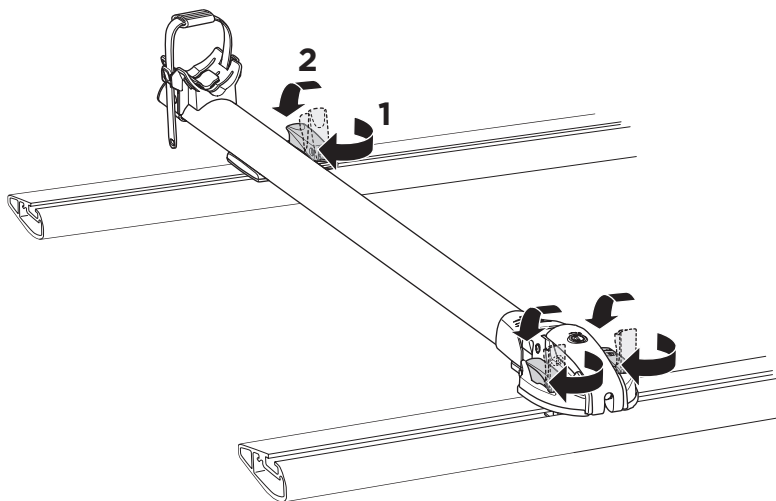

4

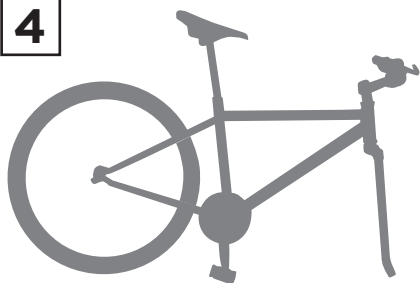

9 mm Quick Release:

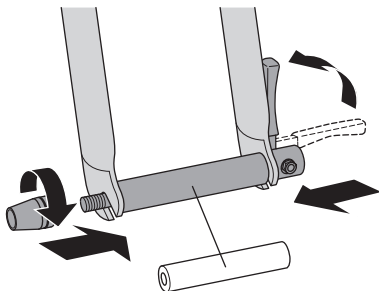

12-20 mm Thru Axles:

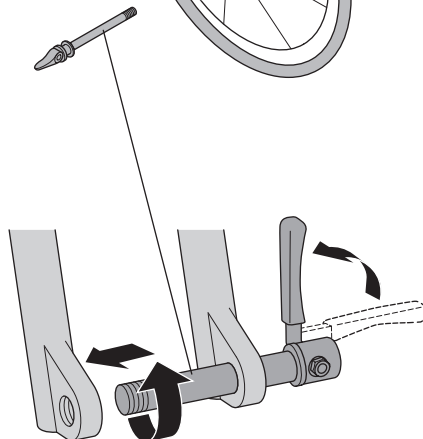
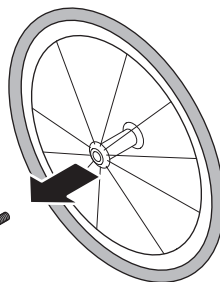

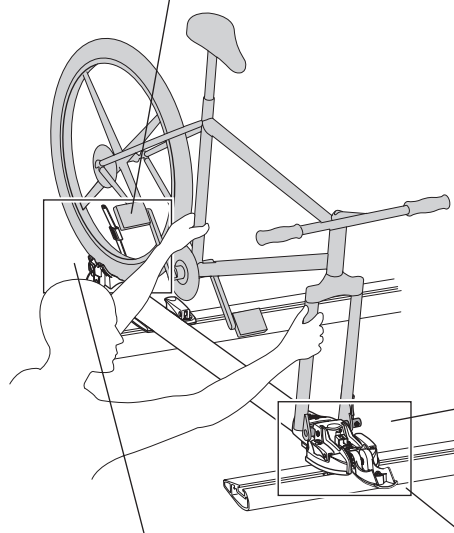
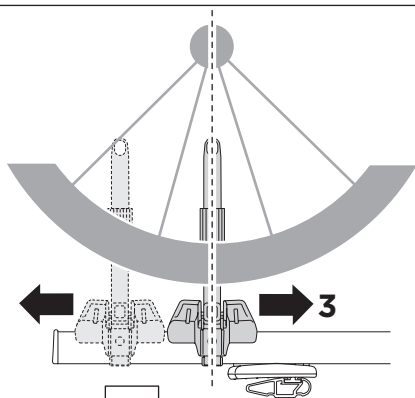
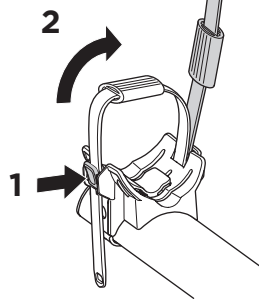
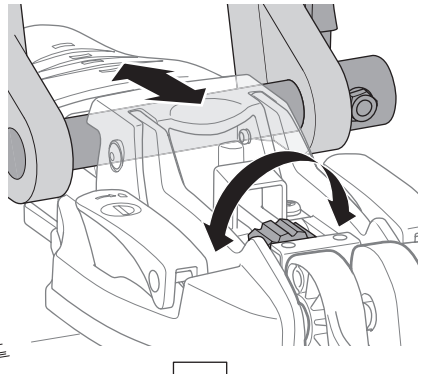
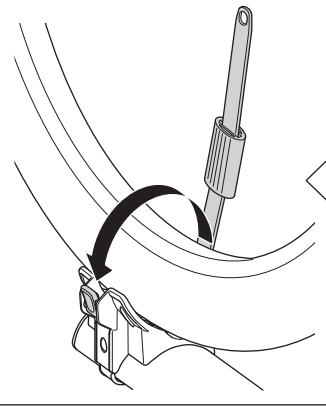
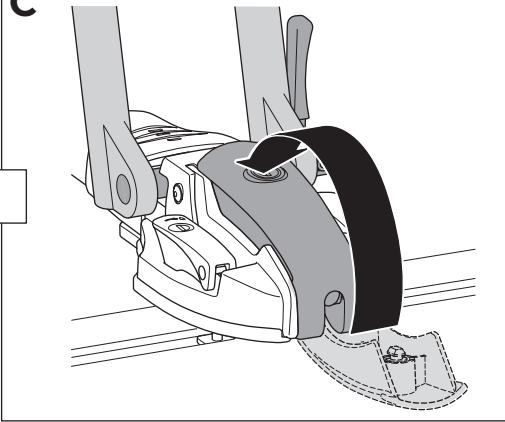
**5****A****B****D****C**

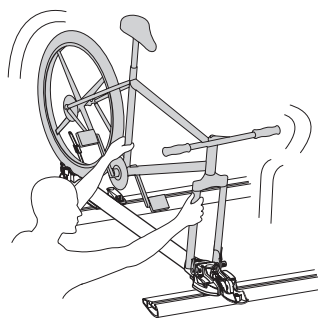
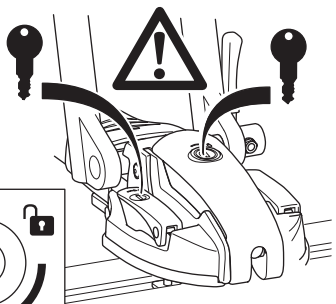
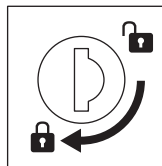
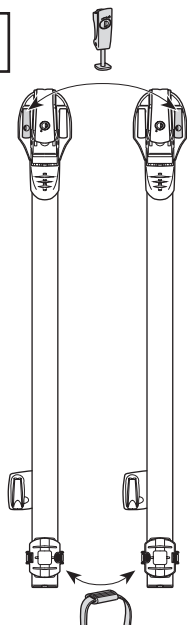
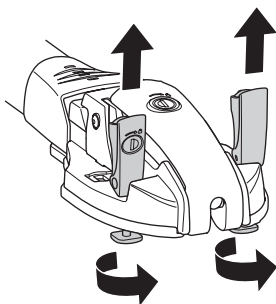
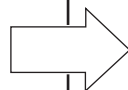
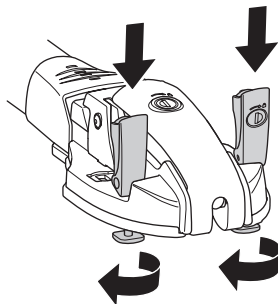
**6****x1****i****EN** Left-hand fitting**DE** Montage links**FR** Montage côté gauche**NL** Montage aan de linker kant**IT** Montaggio a sinistra**ES** Montaje a izquierda**PT** Montagem do lado esquerdo**SV** Vänstermonterad**DK** Venstremontering**NO** Venstremontering**FI** Asennus vasemmalle**ET** Vasakpoolne kinnitamine**LV** Kreisais stiprinājums**LT** Kairysis pritvirtinimas**PL** Montaż z lewej**RU** Установка на левую сторону**UK** Установка на ліву сторону**BG** Монтаж отляво**CS** Montáž z levé strany**SK** Montáž na ľavej strane**SL** Pritrjevanje z leve strani**HR/BiH** Montaža sa lijeve strane**RO** Montare pe partea stângă**HU** Bal oldalról szerelhető**EL** Τοποθέτηση αριστερά**TR** Sol elle montaj**AR** التركيب في الجانب الأيسر**HE** התקנה מהצד השמאלי**ZH** 从左侧安装**JA** 左手装着**KO** 왼손 장착**TH** ตัวยึดด้านซ้ายมือ**A****B**

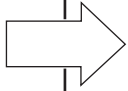

**i**

**C**

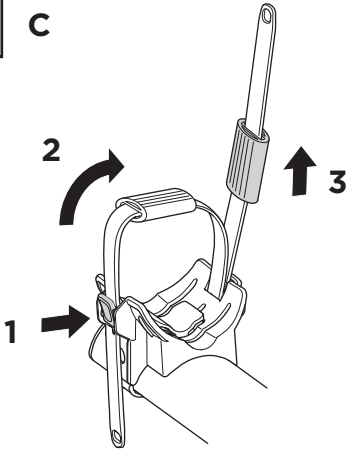

**D**

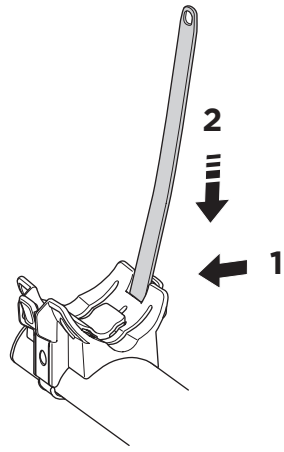

**E**

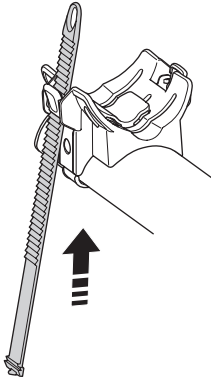

**F**

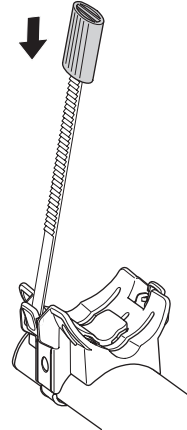

**i**

**9 mm Quick Release:**

**12-20 mm Thru Axles:**

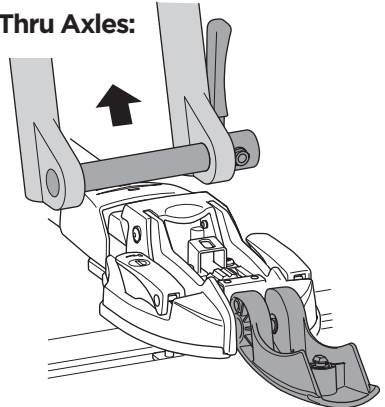
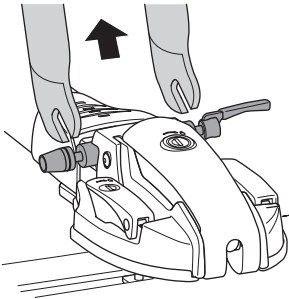

<b>EN</b> Accessories	<b>DK</b> Tilbehør	<b>UK</b> Аксессуары	<b>EL</b> Εξαρτήματα
<b>DE</b> Zubehör	<b>NO</b> Tilbehør	<b>BG</b> Принадлежности	<b>TR</b> Aksesuarlar
<b>FR</b> Accessoires	<b>FI</b> Lisävarusteet	<b>CS</b> Doplňky	<b>الملاحقا</b> <b>AR</b>
<b>NL</b> Accessoires	<b>ET</b> Lisavarustus	<b>SK</b> Príslušenstvo	<b>אביזרים</b> <b>HE</b>
<b>IT</b> Accessori	<b>LV</b> Piederumi	<b>SL</b> Dodatki	<b>ZH</b> 附件
<b>ES</b> Accesorios	<b>LT</b> Priedai	<b>HR/BiH</b> Dodaci	<b>JA</b> アクセサリー
<b>PT</b> Acessórios	<b>PL</b> Akcesoria	<b>RO</b> Accesorii	<b>KO</b> 액세서리
<b>SV</b> Tillbehör	<b>RU</b> Аксессуары	<b>HU</b> Tartozékok	<b>TH</b> อุปกรณ์เสริม

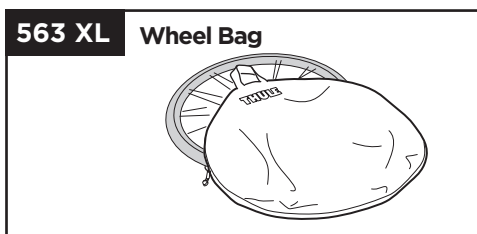
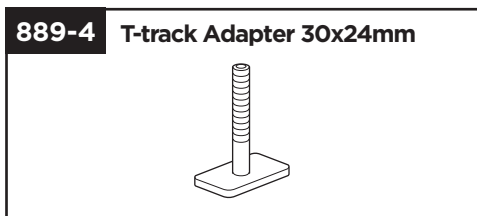
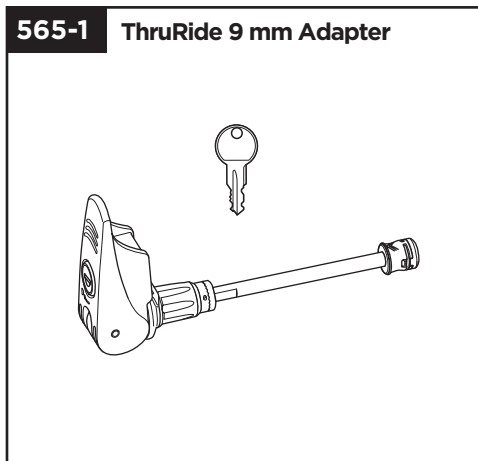

**Thule One-Key System**

<b>544</b>		(x4)
<b>596</b>		(x6)
<b>588</b>		(x8)
<b>452</b>		(x12)

